

NIDE
JUST FOR EASY

Company Introduction

Provide our customers with full package of optimized solution to motor manufacturing



www.nidegroup.com



CONTENTS

01

Company Introduction

PART ONE

02

Product and Application

PART TWO

03

Marketing and Service

PART THREE

01

Company Introduction

Company profile, scene display, new factory planning, sales over the years, development orientation, logo interpretation, corporate culture



PART ONE



Nida Group owns the following four companies and three overseas joint ventures

Ningbo Nide Mechanical Equipment Co.,Ltd -- Group Head quater

Jiangsu Nide Automation Tech Co.,Ltd -- Induction motor stator manufacturing line

Zhejiang Nide Intelligent Automation Co.,Ltd -- BLDC stator , rotor , and motor assembly line

Ningbo Haishu Nide International Co.,Ltd -- Motor components , motor manufacturing technical supports and project contracting

Nide India PVT - Indian market promotion, after-sales service, and some equipment assembly

Nide USA LLC- North American market promotion and after-sales service

NIDE Europe SRL (in process) -- North American market promotion and after-sales service

European R&D, sales center, after-sales service



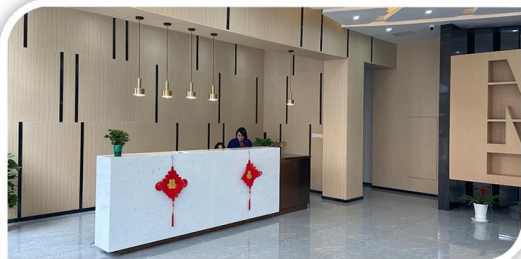
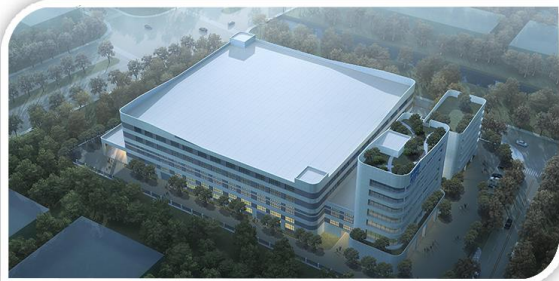

03

New plant



PART ONE



covering an
Area of
25.3 acres



construction
area of
46000 m²



production
capacity
increased by
4 times.



2007

NIDE was founded in September 2007

Ningbo NIDE 2007

Ningbo Haishu NIDE 2007

Jiangsu NIDE 2013

Zhejiang NIDE 2018

NIDE India 2022

NIDE USA 2022

Nide Europe SRL Italy (in process)

79

R&D 79

The company has **286** employees, including **60** mechanical designers and **19** electrical engineers

300000000

Turnover in recent years

Sales exceeding RMB **150 million** in 2020

Sales exceeding RMB **200 million** in 2021

Sales exceeding RMB **300 million** in 2022

21

Patent&Certificate

21 invention patents, **23** cases are in process.

Certificate: **ISO 9001: 2015**, **CE certificate**

50

Product sales network and after-sales center

Sales offices in **11** countries, with after-sales service centers in **Switzerland, Brazil, India and Mexico**.

Products are sold to more than **50** countries and regions.





A leading high tech company striking to provide customer with optimized solution for motor manufacturing

Company orientation

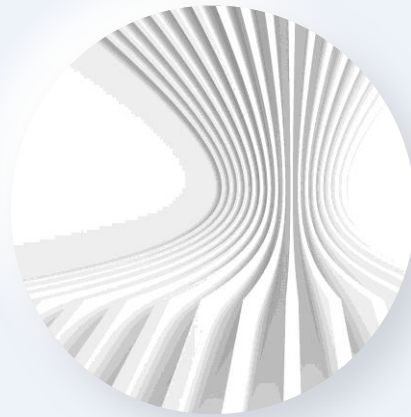

High-level customer

Market orientation



Focus on automatic stator, rotor and motor assembly line, and some other customized motor manufacturing machines.

Product orientation



To make motor
manufacturing
easier



Everything we
are doing is to
make customer
easier



Mission

Transmit value
Realize dream
Take responsibility



Vision

Provide customer with
the optimized solution to
motor manufacturing.



Philosophy

Service, profession, Prompt,
Sincere, Innovation

02

Product and Application

Three business sectors : induction motor production line, BLDC motor production line, Hair-pin motor production line, new energy round wire motor production line, rotor die-casting production line, series motor production line, in-wheel motor production line, various winding methods, MES system, motor stack piece.



PART TWO

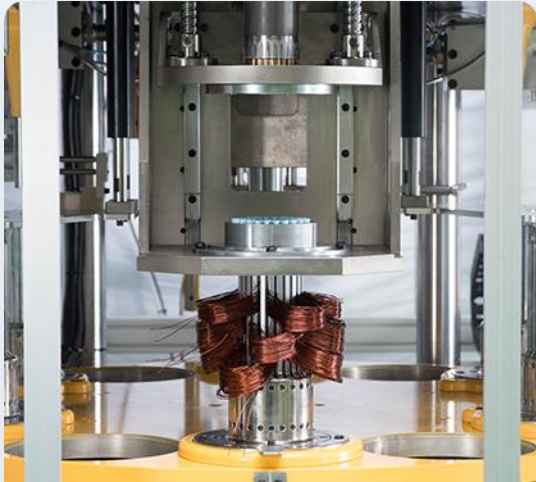

Motor
manufacturing
machines

Core Business

Stator and rotor winding
automation equipment, motor
automation assembly



Motor components

For international markets

Provide customers with cost-
effective motor spare parts
Commutators, bearings, shafts,
carbon brushes, magnets, etc.

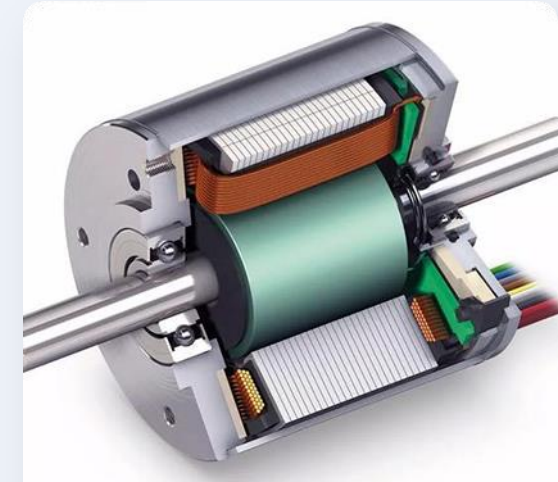

Motor manufacturing
technology
consulting and
project contracts

For international markets

Provide consulting on motor
manufacturing technology and
contracting of foreign projects



11

Induction motor production line--stator/rotor/motor assembly line



PART TWO



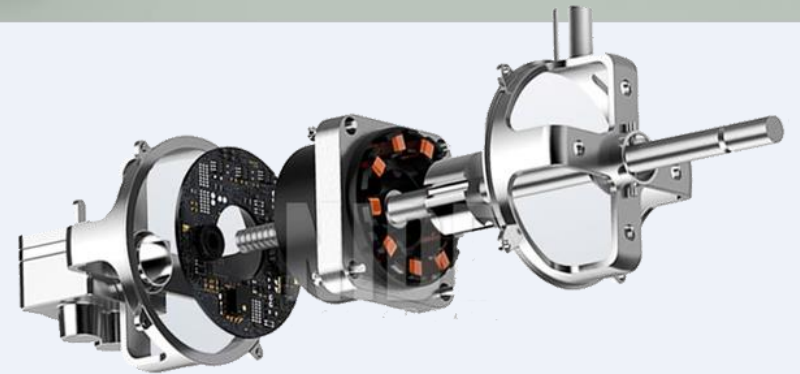
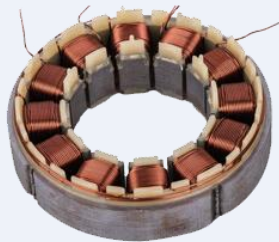
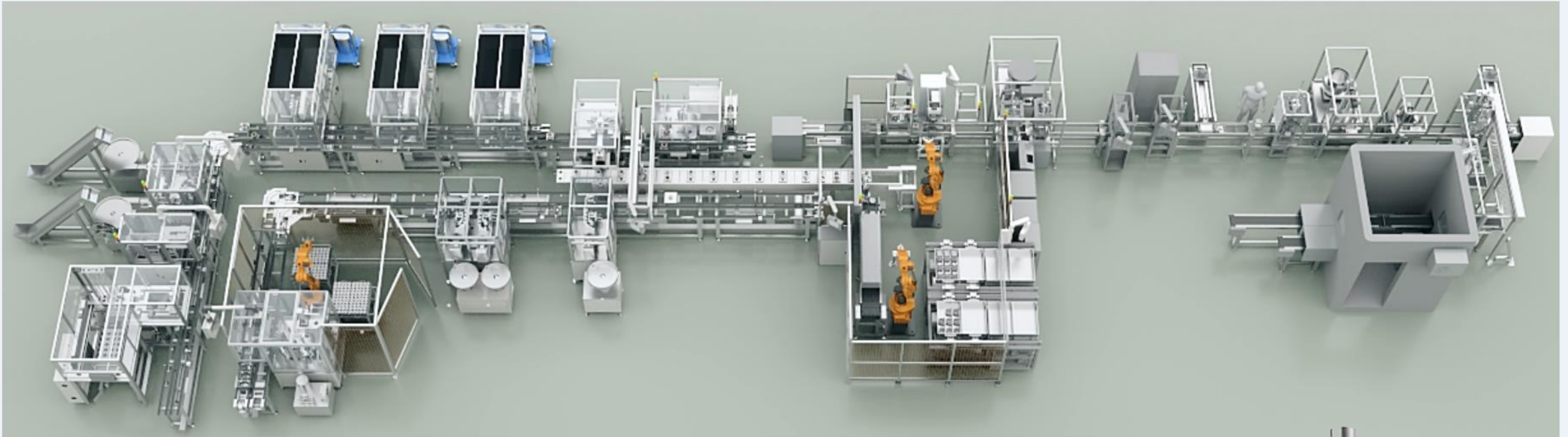

13

New energy round wire motor production line-- stator/rotor/motor assembly line



PART TWO

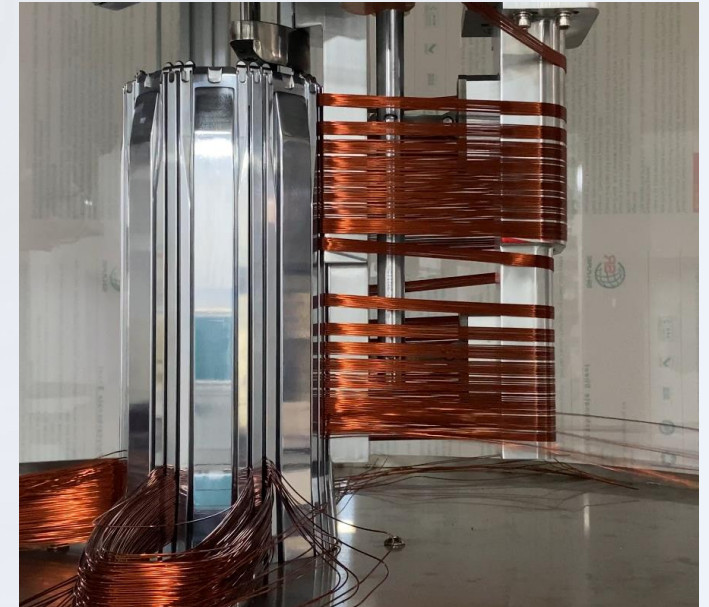
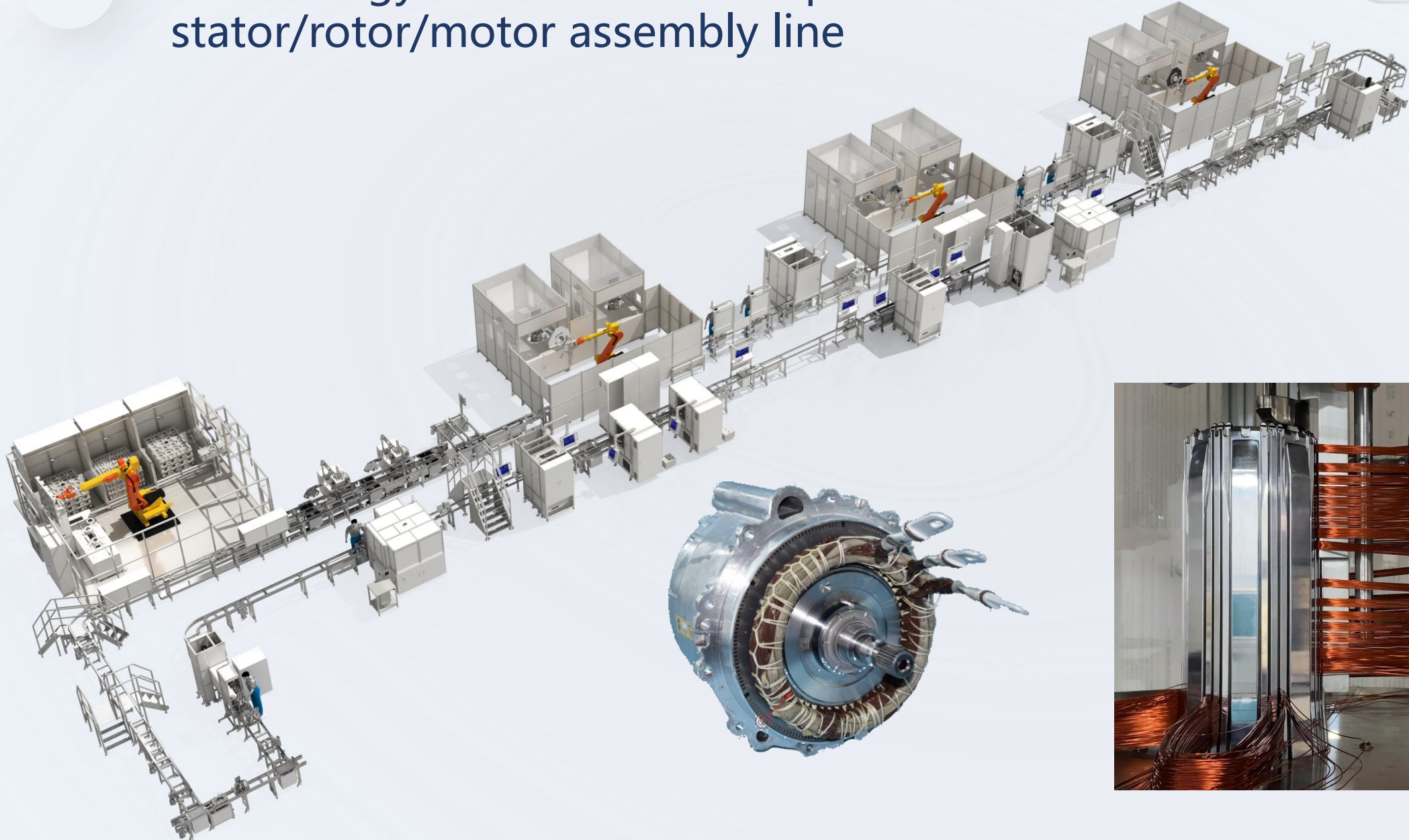

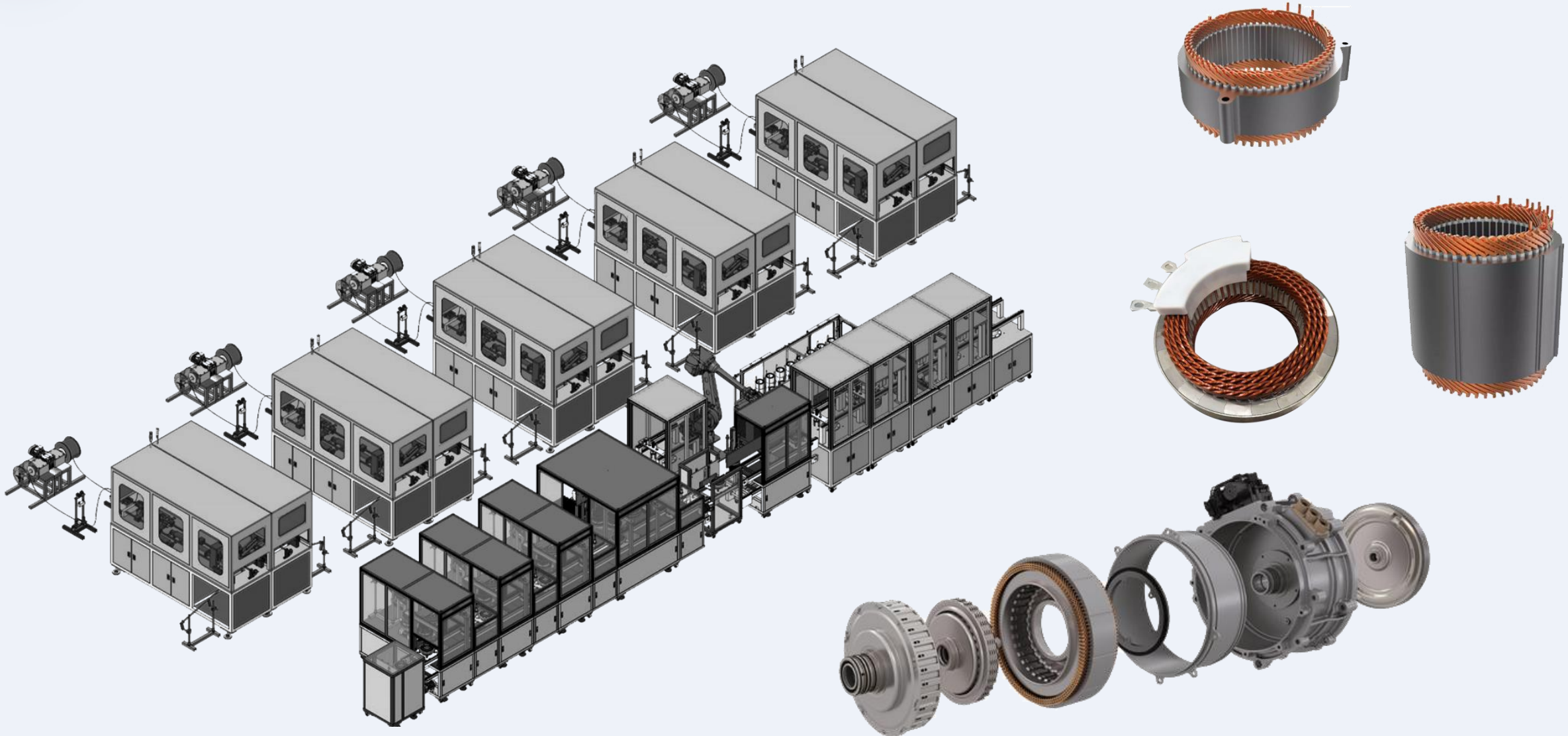

15

Rotor die-casting production line --copper casting is under development



PART TWO

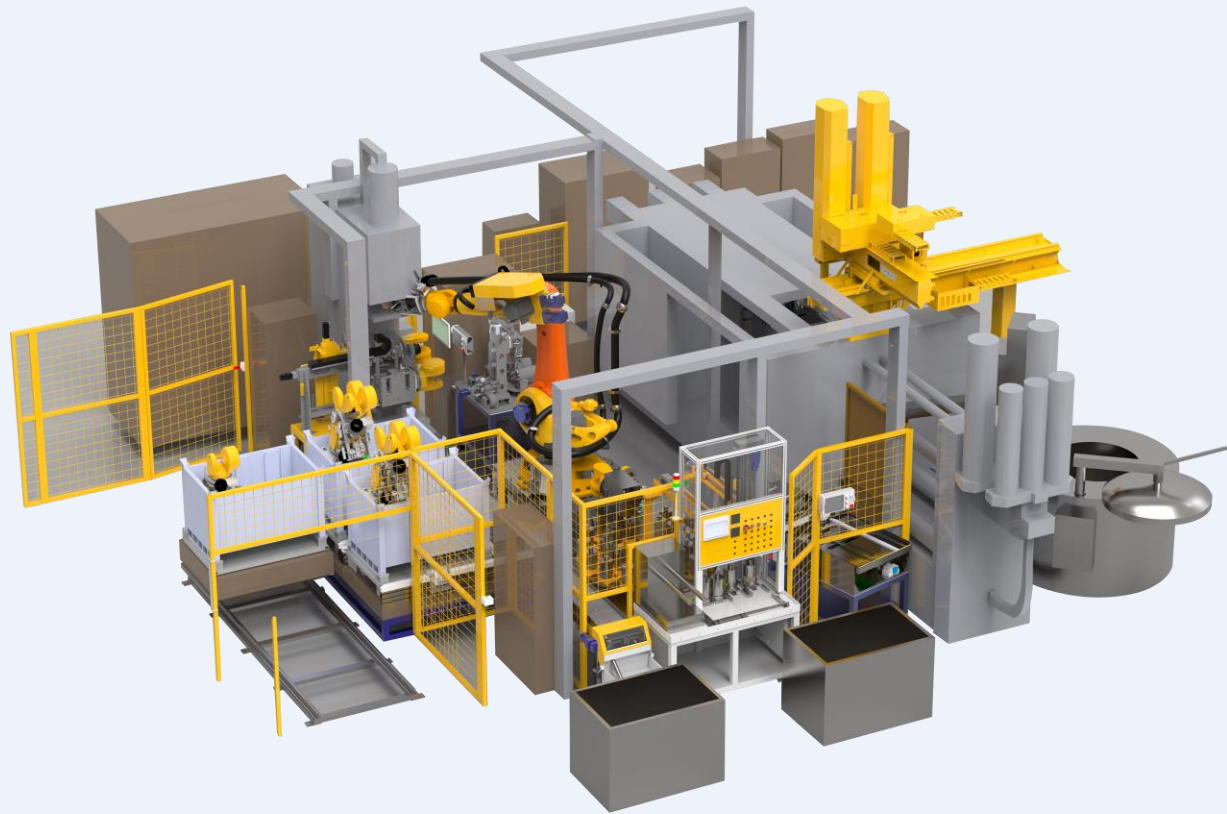

Aluminum rotor casting automatic production line

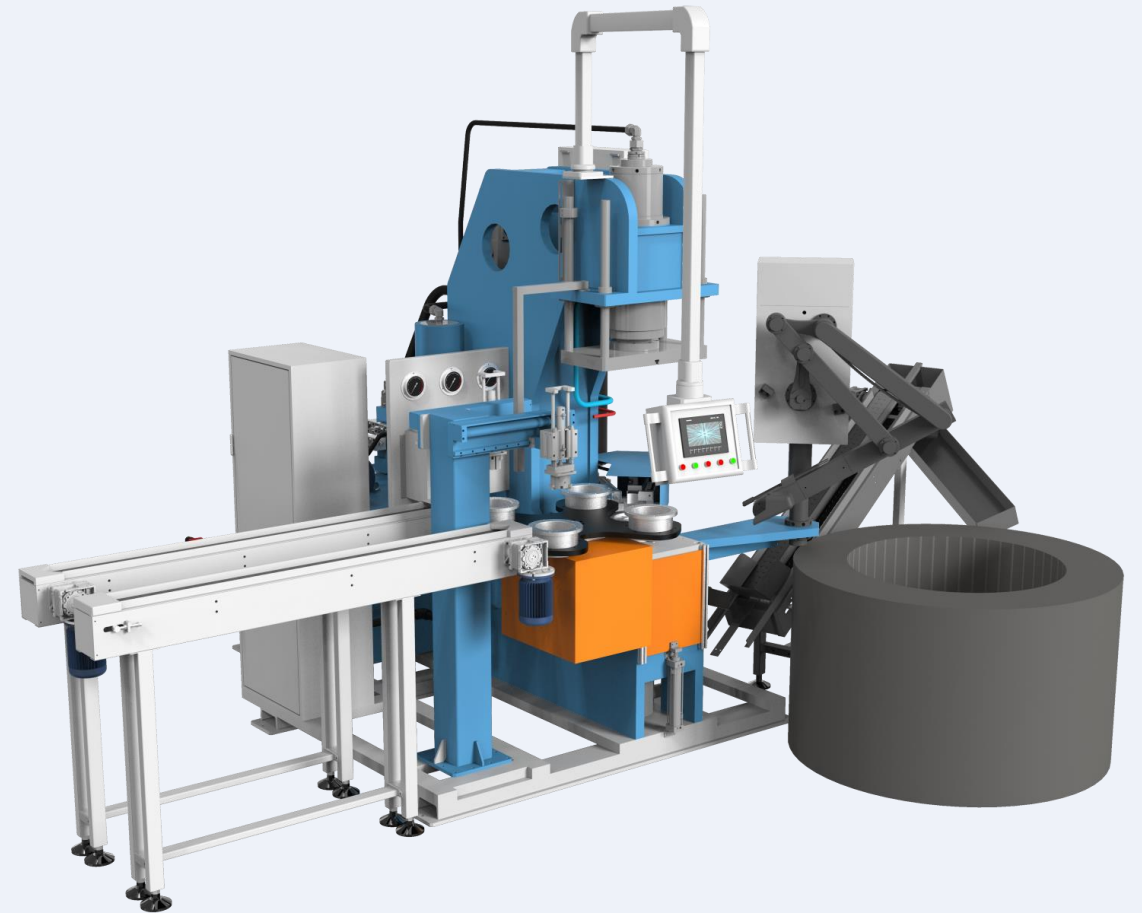

Automatic four-station aluminum rotor casting machine

16

Series motor production line --stator/rotor/motor assembly line



PART TWO





Flyer winding



- ◉ Automatically wound into a wave coil, the number of coils and the length of the wire head can be set arbitrarily, and the wire can be automatically arranged;
- ◉ According to different products, different sizes of wave coils are formed;
- ◉ Automatic clamping head and clamping head rotation technology;
- ◉ Auto-embedding technology;



Needle winding



- ◉ Cable arrangement technology in the winding process;
- ◉ Needle type inner winding and outer winding technology;
- ◉ Multi-wire winding technology;
- ◉ Any stop technology for the angle of the winding needle;

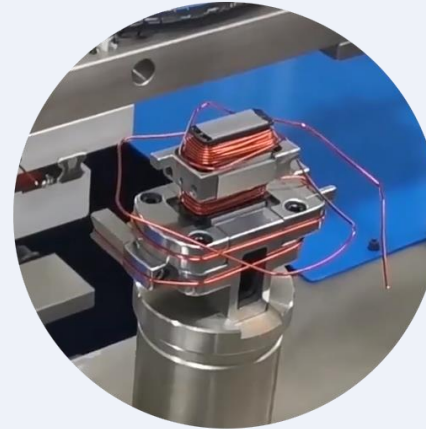

Segment winding

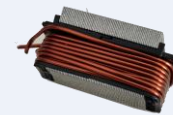

- ◉ Quick change tooling technology;
- ◉ Servo cable shaping technology;
- ◉ The winding tension is precisely controlled by the electric proportional valve;
- ◉ Real-time display technology of winding tension;
- ◉ Winding welding combination technology;

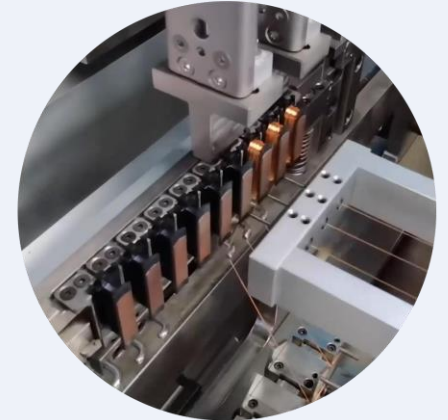

Linear winding



- ◉ Multi-station winding technology;
- ◉ Linear winding technology;



CMS main function modules:

- Equipment monitoring
- Quality analysis
- Recipe management
- Data traceability
- graph analysis
- equipment service
- Alarm management
- Order management
- Report management
- Material management
- Interfacing with third-party management systems

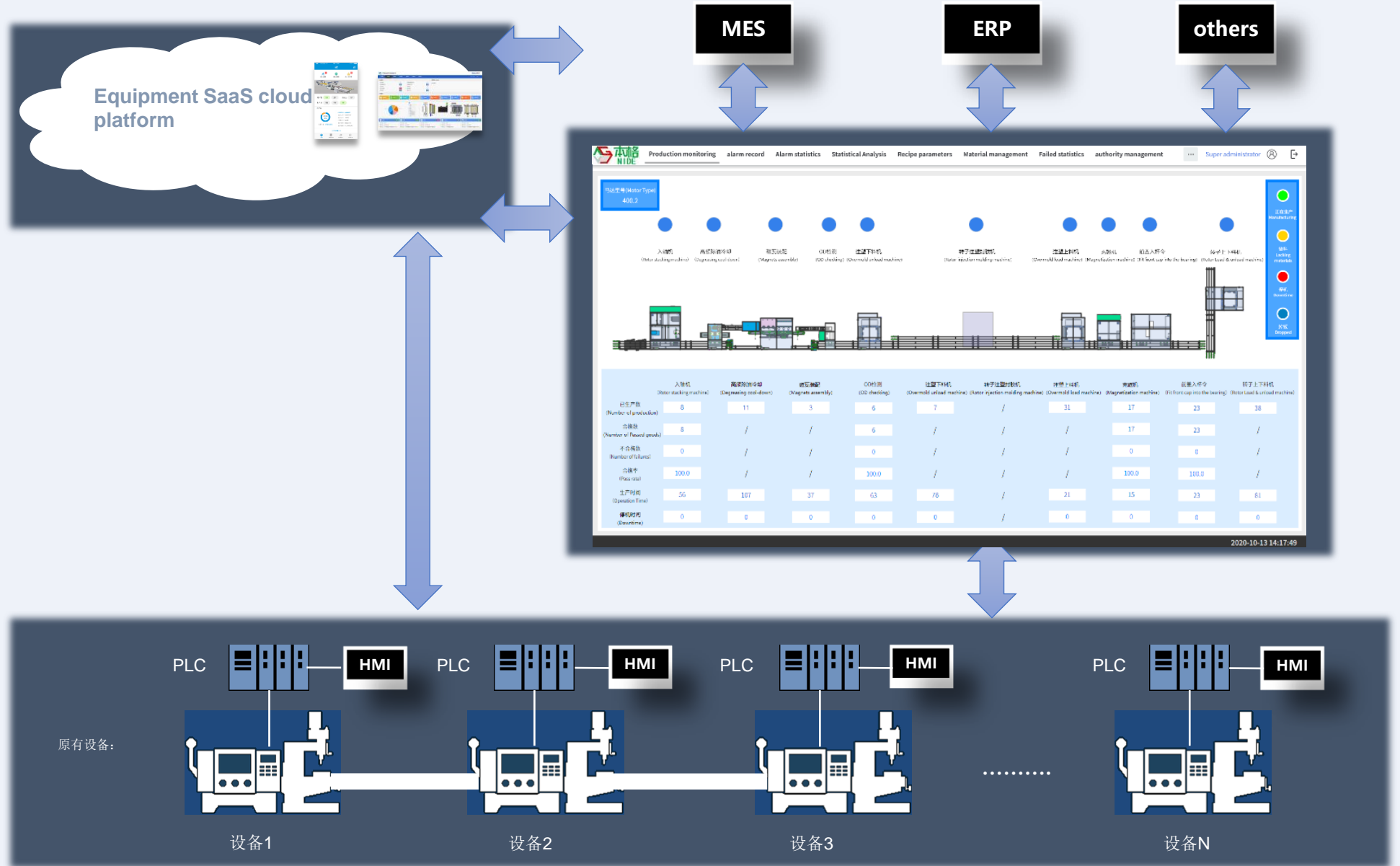

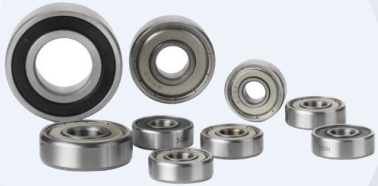

Bearing

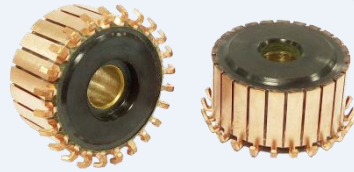

Commutator

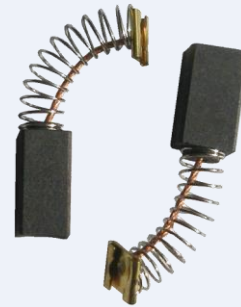

Carbon Brush



Motor Shaft



Magnet

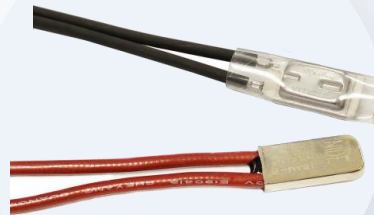

Thermal Protector



Insulation Paper

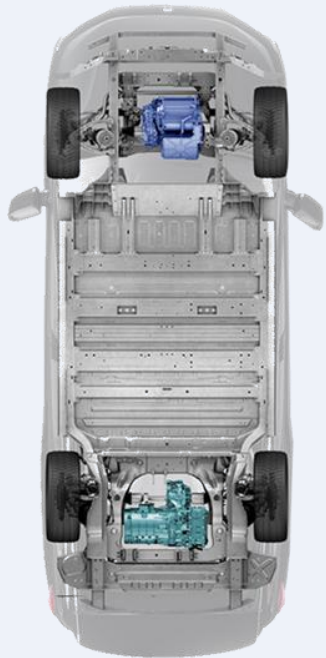

新能源汽车



机床



工业机器人



电梯



发电机



空调



冰箱



吸尘器



洗衣机



水泵



手持电钻



电动自行车

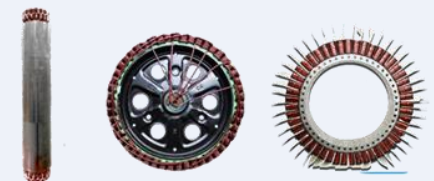
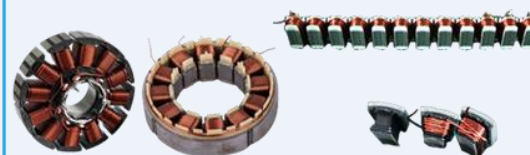
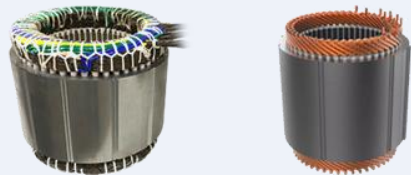



**BLDC motor automatic
production line**



**Induction stator automatic
production line**

03

Market and Service



PART THREE



Cover
most
provinces

Products are sold
nationwide

Qingdao, Suzhou, Ningbo,
Taizhou, Xuancheng, Chongqing,
Xiamen and other places have
permanent service points



Mature market



Key developing area

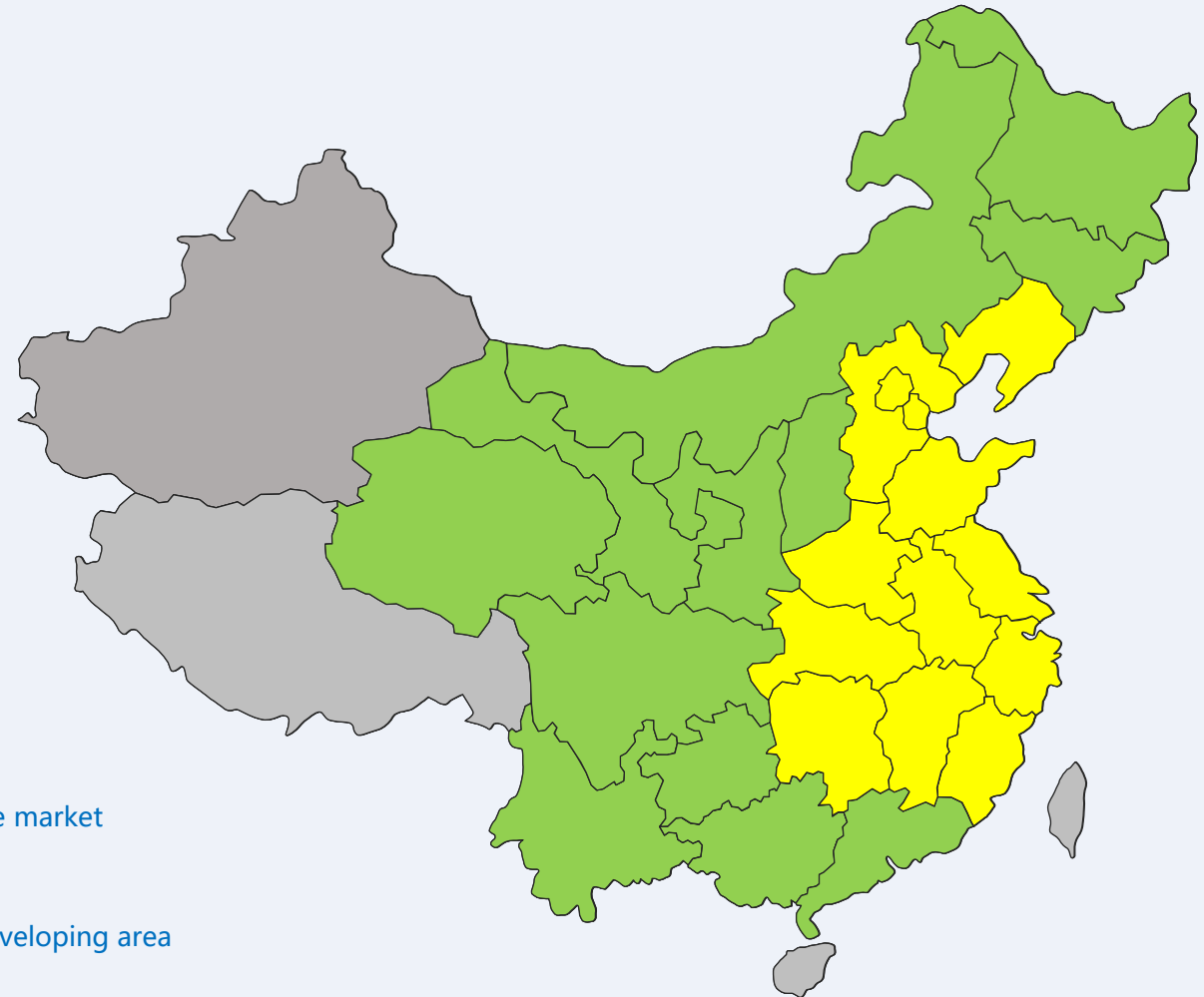

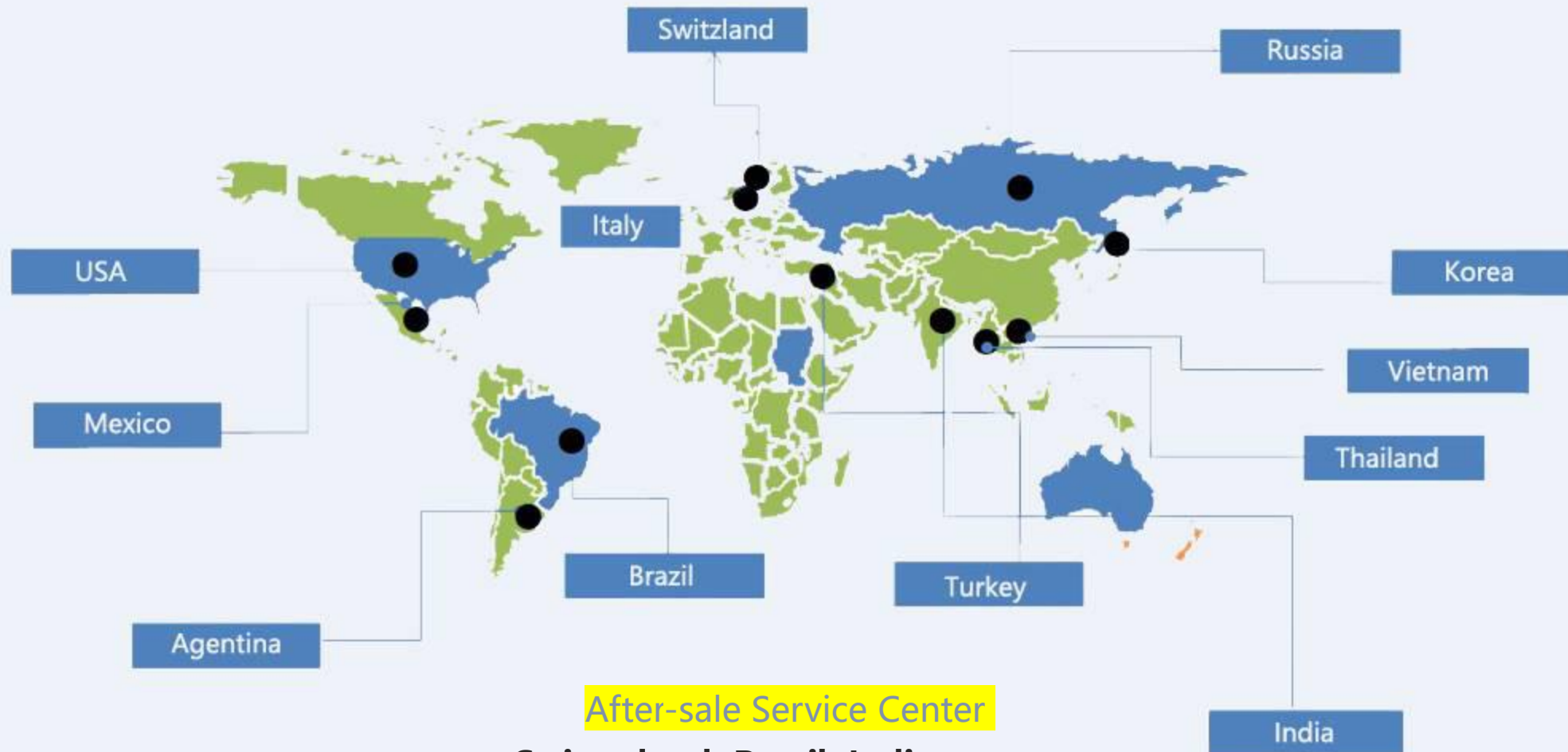

already exported to more than 50 countries and regions





- 1** China domestic:
prompt response within 1hr
- 24** 24hrs international response
- 24** 24hrs global service
hot line
- 48** 48hrs domestic arrival at site

Domestic service: suzhou, ningbo, qingdao, south anhui, taizhou, yangzhou, chongqing, guangzhou, etc.

International service: Mexico, India, Brazil, Switzerland, Italy





2022

Thanks for attention !

T H A N K Y O U

Make Motor, turn to NIDE, everything would be easy!



www.nidegroup.com

